

# **INSTRUCTION MANUAL**

DATE: 2001. 6. 1  
FILE No: FDA.doc  
PAGE: 1 of 27

## **DIGITAL AC PRIMARY VOLTAGE CONTROLLER**

**FDA-series**



**I.H. ELEMA ENG. CO., LTD.**

TEL: +82-31-498-9270~4

FAX: +82-31-498-9275

1.

2.

3.

4.

5.

6.

7.

8. KEY

9. KEY

10. KEY

11.

12.

13.

14.

15.

16. Parameters

◆ **Trouble Shooting Guide**

1.

FDA-series  
THYRISTOR

3 3

1

, 가  
FDA-series

THYRISTOR

, 가

가

2.

software

relay

가  
가 ,

key

10

key

가

nv-RAM  
4

4

가

EMI

3.

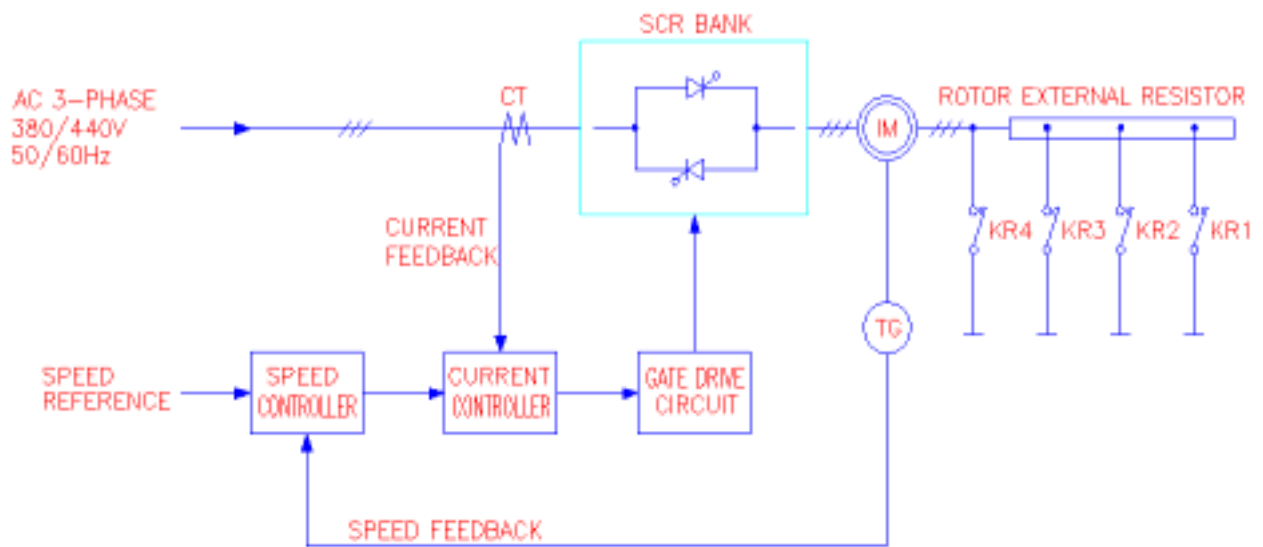

4.

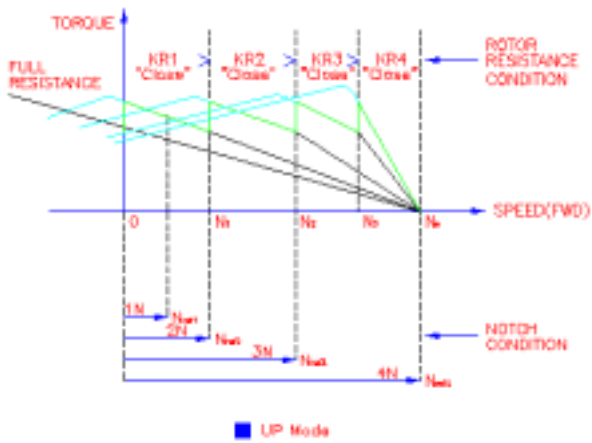

■ UP Mode

Mode		KR1	KR2	KR3	KR4
UP	1N				
	2N				
	3N				
	4N				
DOWN	1N				
	2N				
	3N				
	4N				

■ Vertical Mode

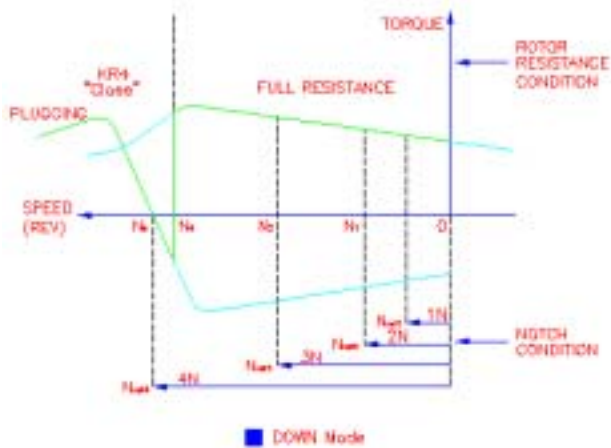

■ DOWN Mode

Mode		KR1	KR2	KR3	KR4
UP	1N				
	2N				
	3N				
	4N				
DOWN	1N				
	2N				
	3N				
	4N				

■ Horizontal Mode

“ ” : CLOSE

5.

**UP Mode**

1	2		Nref1	Nref2		KR1	
3		Nref3		가	가	N <sub>1</sub>	KR2
4		Nref4		가	가	N <sub>2</sub> 가	KR3
		N <sub>3</sub> 가	KR4		2	0	
		가					

**DOWN Mode**

1	, 2	, 3		2			
	Nref1, Nref2, Nref3						
4		Nref4		가	가	N <sub>4</sub> 가	KR4

UP Mode

6.

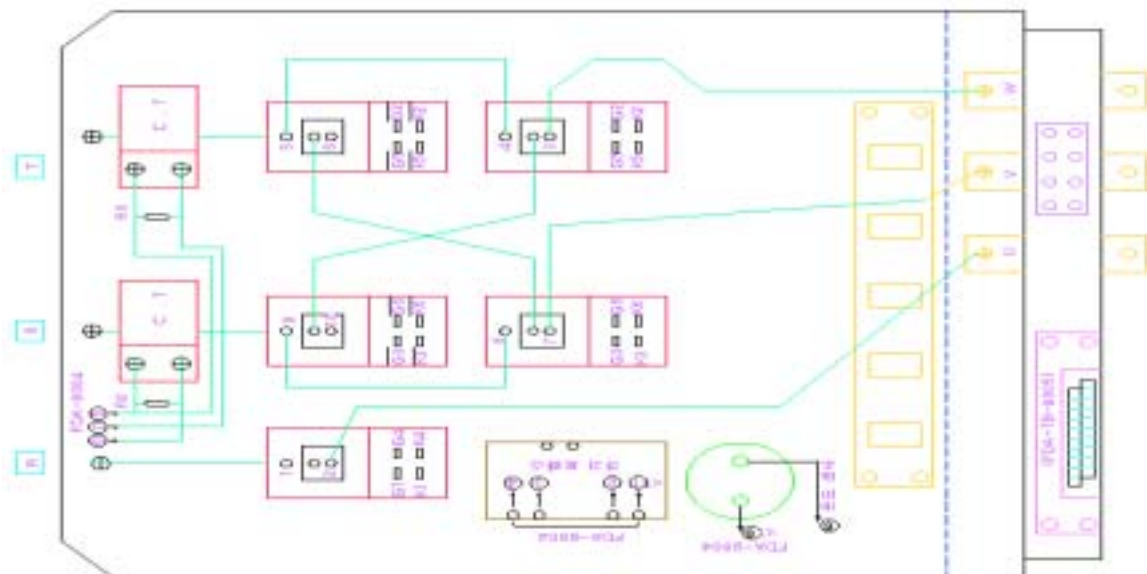

7.

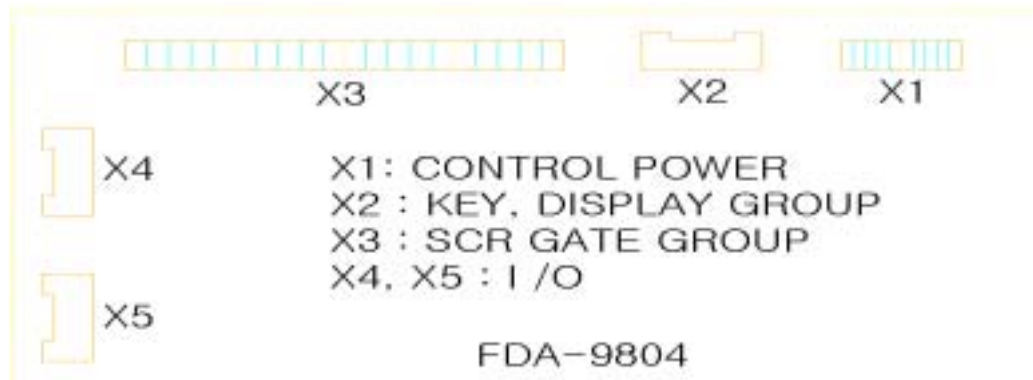

8. KEY

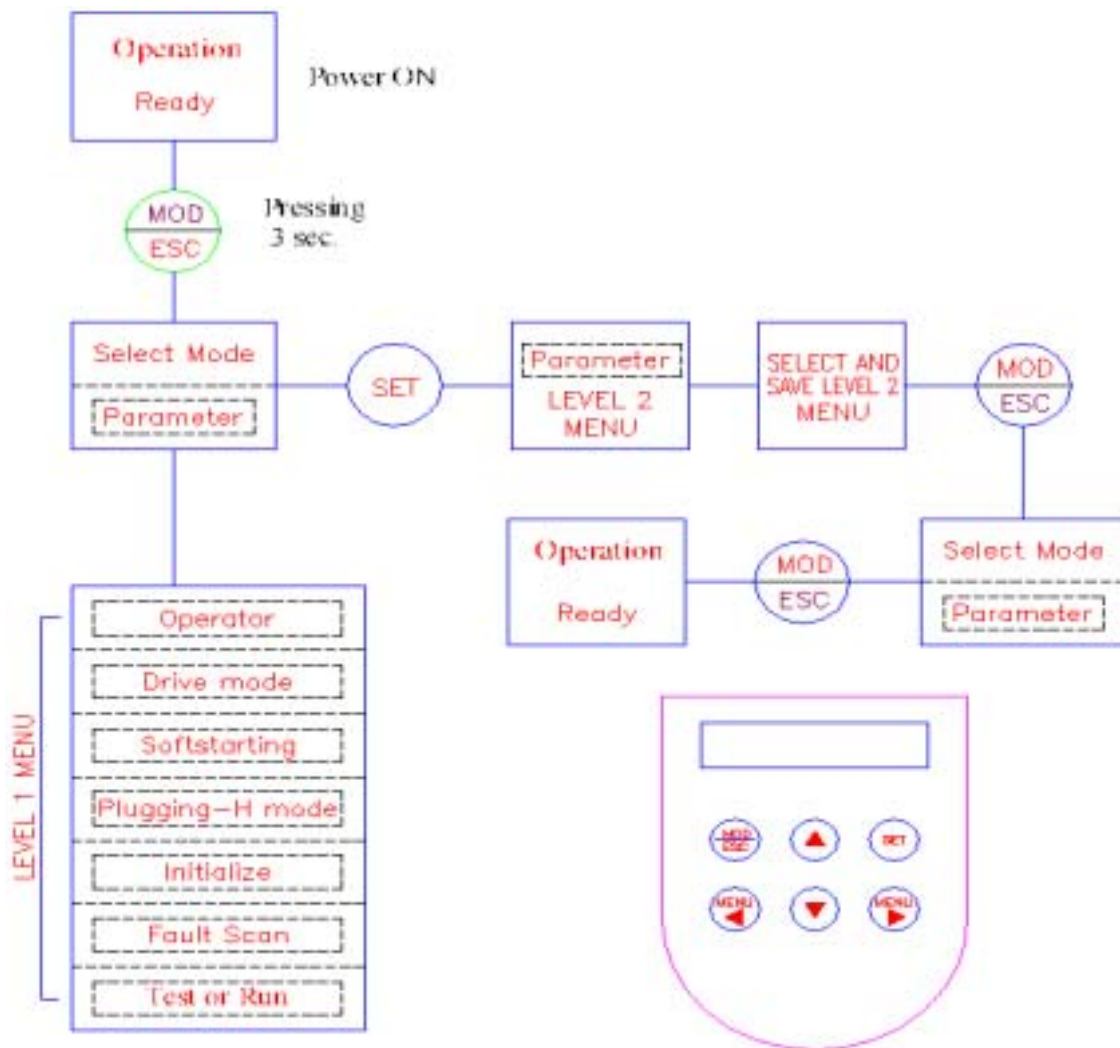

**9. KEY**

KEY	EXPLANATION
<u>MOD</u> ESC	1 ESC
SET	SET
	가
MENU	MENU 가
MENU	MENU 가



KEY	EXPLANATION			
SELECT MODE	MENU LEVEL 1	MENU LEVEL 2	RANGE	DEFAULT
	PARAMETER	GAIN KP	1 1999	600
		GAIN KI	0 999	20
		CURRENT GAIN	1 300	50
		SOFTSTART TIME	200 12000	2000 [ms]
		SOFTSTOP TIME	0 12000	2000 [ms]
		CURRENT LIMIT	50 400	150 [%]
		OVER CURRENT	100 450	300 [%]
		OC count set	5 ~ 25	25
		Sync_Speed [Ns]	600 1800	720 [rpm]
		NREF1	5 25	15 [%]
		NREF2	20 40	30 [%]
		NREF3	50 80	60 [%]
		NREF4	95 110	110 [%]
		N0	3 40	10 [%]
		N1	20 50	30 [%]
		N2	50 80	60 [%]
		N3	70 100	80 [%]
		N4	80 100	90 [%]
		DELTA N	1 110	10 [%]
		OFF DELAY TIME	1 9000	4000 [ms]
	PLUGGING LIMIT	10 200	150 [%]	
	BRAKE CLOSE TIME	0 9000	500 [ms]	
	MOTOR CUR DG	0 ~ 100 [%]	100 [%]	
	Jog Start Time	0 ~ 10 [%]	7 [%]	
	OPERATOR		STICK / POTENTIO	STICK
	DRIVE MODE		VERTICAL / HORIZONTAL	VERTICAL
	SOFT STARTING		ON / OFF	ON
	PLUGGING - H MODE		ON / OFF	ON
INITIALIZE		FAULT INIT / PARAMETER INIT	FAULT INIT	
FAULT SCAN		0 9	0	
TEST OR RUN		TEST MODE / RUN MODE	RUN MODE	
Modify?		ON / OFF	OFF	

**10. KEY**

Operator ( )  
 Potential type  
 Stick type .

Drive mode ( )  
 가 , 가

Soft starting ( 가 )  
 가 .

Plugging-H mode ( )

Initialize ( )  
 Fault init  
 Parameter init

DEFAULT .

Fault scan ( )

Delta N ( )  
 가 .

**11.**

1)

ITEM	TYPE FDA-															
	37H		45H		100H		200H			250H		300H	400H	600H		
Motor Capacity [kW]	2.2	3.7	5.5	7.5	11	15	22	30	37	45	55	75	90	110	132	
Rated Output Current [A]	6.5	10	13	17	25	29	39	54	61	72	106	141	167	209	251	
SCR Quantity	5EA												10EA			
Power Source	3Ph 380/400/440/460/480 [V] 50/60 [Hz]															
Permissible Voltage Fluctuation	± 10[%]															
Permissible Frequency Fluctuation	± 5[%]															
Control Method	Full digital type primary voltage control															
Speed Setting Signal	DC 0 ~ 5[v] or Notch input signal (4 notch)															
Speed Detection Signal	Tacho – Generator															
Motor Protection	Short circuit protection and electronic thermal function															
Over Current	Current limit setting (setting up to 300[%])															
Stack Overheat	Protection by thermal switch at 85 [°C]															
Ambient Temperature	-10 ~ +50 [°C]															

2)

ITEM	700H	1000H	1300H	1300H
Motor Capacity [kW]	160	200	300	
Rated Output Current [A]	296	367	541	
SCR Quantity	10EA			

12.

1000 [m]  
 -10 [ ] ~ +50 [ ]  
 가 가

R-S-T

13.

R-S-T

14.

Air filter  
 Air filter 가 10 Thyristor 가  
 3 ~ 6 1 10  
 Thyristor

SCR

SCR  
 SCR  
 P.C.B  
 P.C.B P.C.B

15.

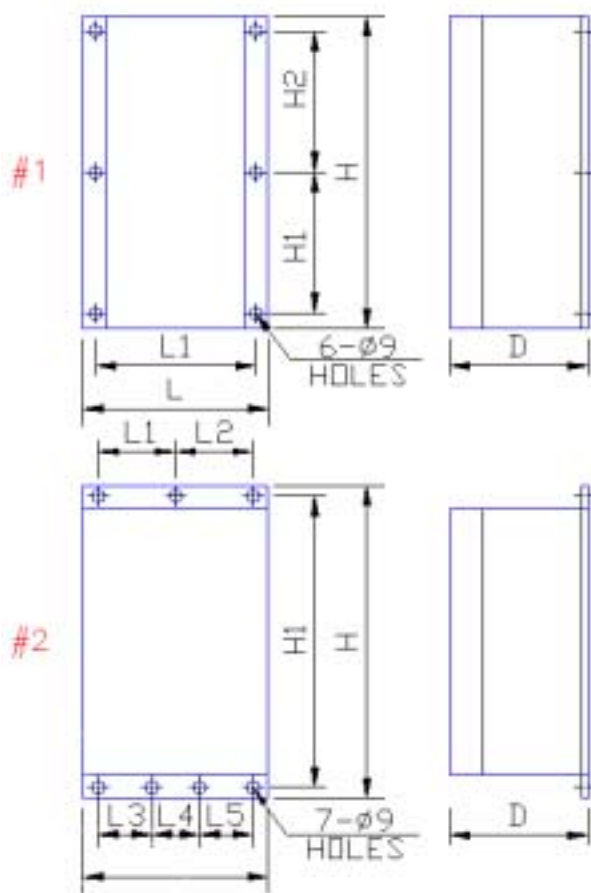

(UNIT : mm)

MODEL TYPE	MODEL SIZE	OUTLINE DIMENSION			MOUNTING DIMENSION						
		L	H	D	L1	L2	L3	L4	L5	H1	H2
FDA-37H	#1										
FDA-45H											
FDA-100H											
FDA-200H		293	500	265	276	*	*	*	*	220	220
FDA-250H											
FDA-300H											
FDA-400H											
FDA-600H		390	553	250	370					220	220
FDA-700H	#2										
FDA-1000H		490	1011	288	220	220	146	148	146	981	*
FDA-1300H											

### 16. Parameters

Parameter	Crane		Key-board
	LCD		
Parameter	Unit	( )	EPROM
nv_RAM	Initialize	EPROM	Default
nv_RAM			

LCD Display

Unit ( )

“ Operation ”  
 “ Ready ” 가 Display

Unit

- |      |                  |         |
|------|------------------|---------|
| MENU | MENU             |         |
|      | REV (down)       | 0       |
|      | FWD (up)         | 1       |
|      | Speed-A =        | 15 %    |
|      | Speed =          | *** RPM |
|      | 1notch           |         |
|      | i <sub>c</sub> = | 20 %    |
|      | i <sub>b</sub> = | 20 %    |
|      | =                | * °     |
- Parameter

### 16.1 (SETUP PARAMETERS)

#### 16.1.1

1 touch off (MOD/ESC) 1 가 LCD

Parameter

- (MENU) (MENU) :
- ( ) :
- ( ) :

16.1.2

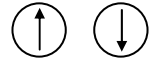
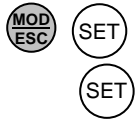

( Operation Ready ) 가 .

16.2

16.2.1 (Parameter)

1. GAIN Kp

Reference T.G Feedback 가 .  
가 가 .

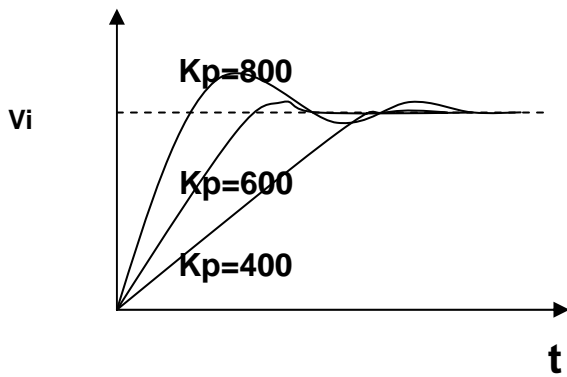

: 1 999  
Default : 600

2. GAIN Ki

Reference T.G Feedback

Gain .

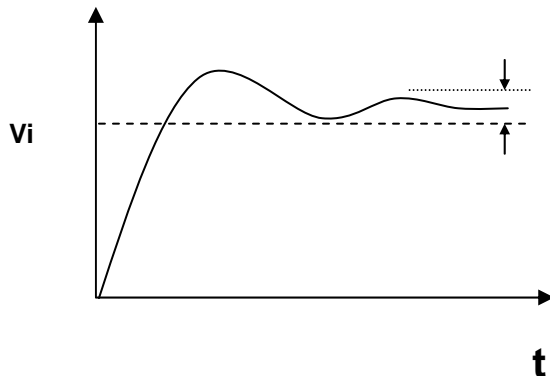

: 1 999  
Default : 20

3. CURRENT GAIN

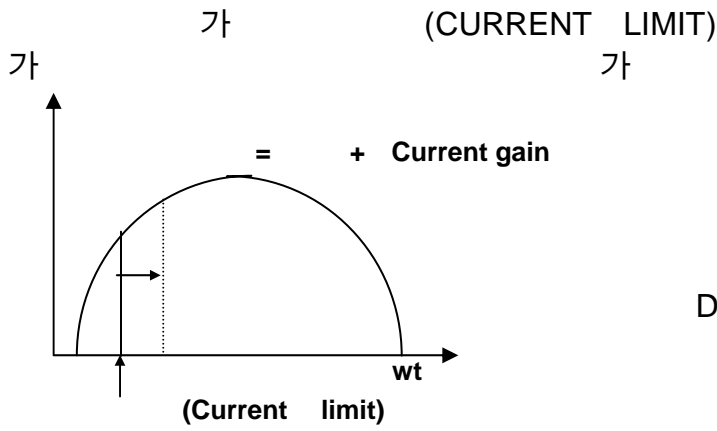

가 Gain .  
 Default : 0 300  
 : 50

4. SOFTSTART TIME

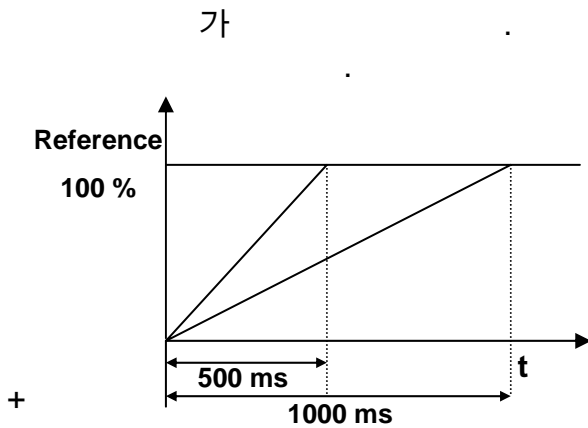

가 Reference 가  
 Default : 400 12000ms  
 : 2000 ( )  
 3000 ( )

5. SOFT STOP TIME

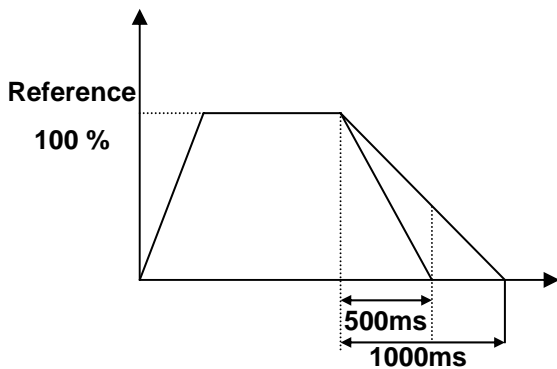

가 Reference 가  
 Default : 400 12000ms  
 : 2000 ( )  
 3000 ( )



**6. OVER CURRENT**

가  
2.8 ms .

: 150 450%  
Default : 300%

**7. O.C COUNT SET**

가 2.8ms  
UNIT

O.C COUNT SET  
“ OVER CURRENT ”

: 1 25  
Default : 25

“ OVER CURRENT ”

가 > 2.8 ms X O.C Count Set .

**8. CURRENT LIMIT**

가  
CURRENT GAIN

: 150 1300%  
Default : 150%

**9. TACHO REFERENCE**

UNIT LCD Display

RPM

ex) 가 8 (60 Hz)

$$(120 * f) / P = 120 * 60 / 8 = 900 \text{ rpm}$$

: 720 ~ 1200 rpm  
default : 1200 rpm

**10. Nref1**

Joistik Controller 1 (reference) Unit  
가 가 .  
: 5 ~ 15%  
default : 15%

**11. Nref2**

Joistik Controller 2 (reference) Unit  
2 가 가 .  
: 20 ~ 40%  
default : 30%

**12. Nref3**

Joistik Controller 3 (reference) Unit  
3 가 가 .  
: 50 ~ 70%  
default : 60%

**13. Nref4**

Joistik Controller 4 (reference) Unit  
4 가 가 .  
: 95 ~ 110%  
default : 110%

**14. N0**

Unit Relay Brake close "KB" 가 off . NO  
: 3 ~ 15%  
default : 10%  
· N0 > T.G Unit Relay KB 가 off .

**15. N1**

T.G feedback N1 Unit 2  
 Relay KR2 .  
 : 20 ~ 40%  
 default : 30%  
 . N1 < T.G Unit Relay KR2 가 .  
 . Stick 3 KR2 가

**16. N2**

T.G feedback N2 Unit 2  
 Relay KR3 .  
 : 50 ~ 70%  
 default : 60%  
 . N2 < T.G Unit Relay KR3 가 .  
 . Stick 4 KR3 가

**17. N3**

T.G feedback N3 Unit 2  
 Relay KR4 .  
 : 80 ~ 110%  
 default : 80%  
 . Ns < T.G Unit Relay KR4 가 .  
 . Stick 4 KR4 가

**18. N4**

Vertical mode(Hoist mode) down Plugging 1,2,  
 3 N1 ~ N3 , 4 motor  
 feedback N4 KR4 가 . , down 4  
 : 80 ~ 100%  
 default : 90%  
 . Hoist down 4 N4 < T.G Unit Relay KR4 .

**19. Delta N**

(Plugging) (KR1 ~ KR4 off )  
 (reference) T.G feedback 가

reference – T.G > Delta N  
 : 1 ~ 20%  
 default : 10%

**20. Off delay time**

off delay time  
 가 NO

Hoist down Brake close time  
 : 3000 ~ 9000 ms  
 default : 4000 ms

**21. Plugging Limit(Horizontal mode)**

(Plugging) 가  
 가 Current Limit  
 , Plugging-H mode

Plugging Limt <  
 : 20 ~ Current Limit  
 default : 150%

**22. Motor cur DG**

LCD %  
 display

% display  
 100A / 100 % : 100%



display

**23. Jog start time**

Soft start 가 %  
 : 0 ~ 10%  
 default : 7%

**16.2.2 (Operator)**

1 ~ 4	stick	stick	poti
		1 ~ 4	stick
		potentio	0 ~ 4v
			: Stick / Potentio
			default : Stick

**16.2.3 ( Drive mode)**

	가	( Vertical : Hosit)	( Horizontal :
, )			
			: Vertical / Horizontal
			default : Vertical

**16.2.4 가 ( Soft starting )**

가	On / Off	Off
		: ON / OFF
		default : ON

**16.2.5 ( Plugging – H mode)**

( Horizontal : , )	( Pluggny)
"OFF"	,
(Vertical mode)	
	: ON / OFF
	default : ON

**16.2.6 ( Initialize)**

nv_RAM	default
Fault Initalize Parameter Initalize 가	.
Favlt initialize set	10 가 data
. initialize set	
( Vertical, Horizontal )	default

**16.2.7 ( Fault scan)**

10 , 0 ~ 9  
0 line power off :  
.  
.  
9 over current  
: 0~9  
default : 0

**16.2.8 Check mode ( Test or Run )**

sequence  
RD, KB, KR1 ~ KR4 Relay 가

# KEYPAD

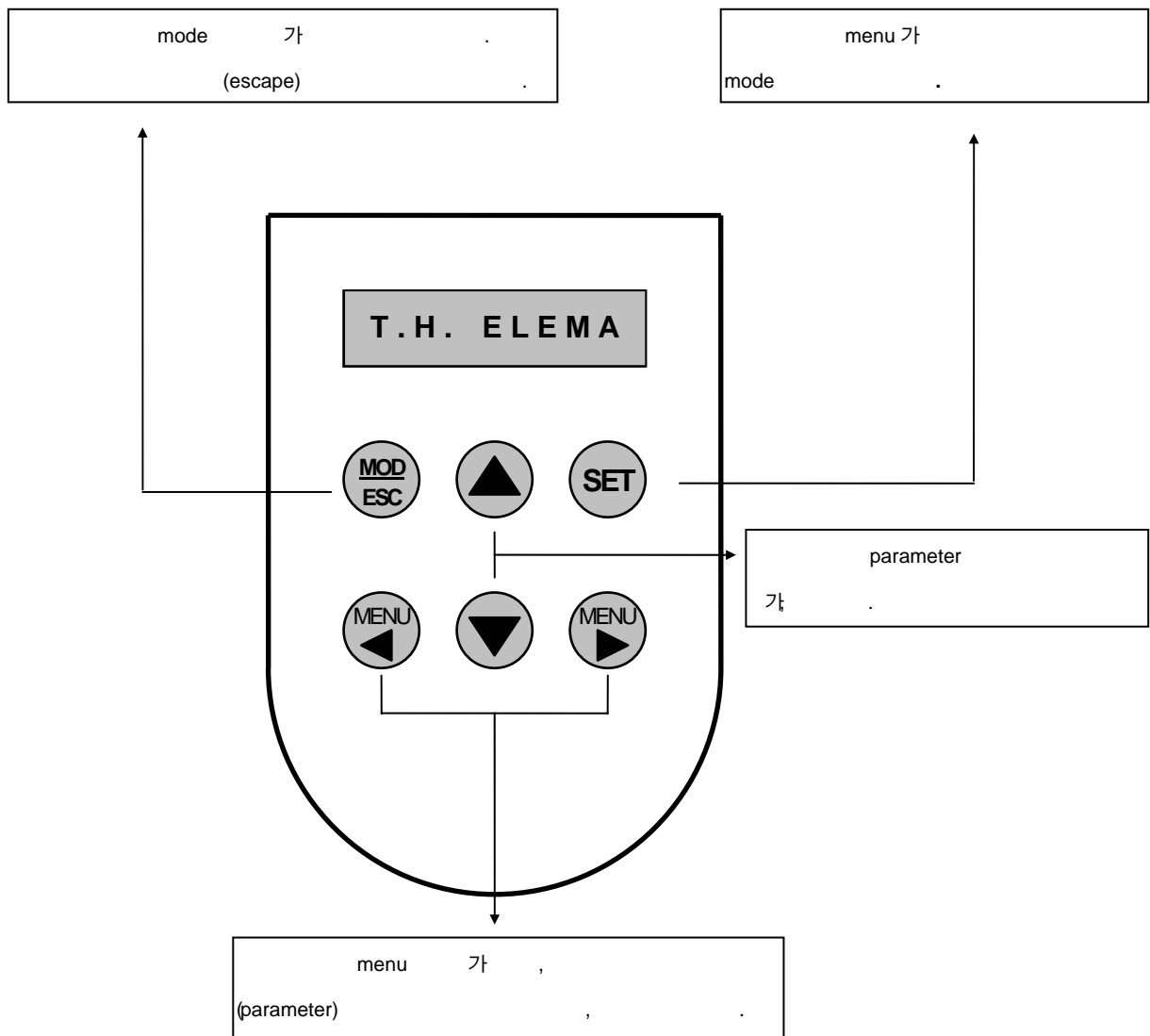

**FDA Trouble Shooting Guide**

FDA unit	Fault	FDA unit	Fault message	,	가
Fault		Fault message	가	,	
		Fault	가		

**Fault List**

- 1 Line power off
- 2 b-CT fault
- 3 c-CT fault
- 4 Tacho fault
- 5 Fuse or LinePwr
- 6 Over heat
- 7 Over current
- 8 Over load
- 9 Tacho line fault
- 10 Over speed
- 11 b Line fault
- 12 c Line fault

- ◆ **Group** - check fault **before** operation : 1, 2, 3, 4, 5
- check fault **during** operation : 1, 5, 6, 7, 8, 9, 10, 11, 12



**1. Fault message : Line power off**

가 :  
 Fault (Vbs, Vcs) 가  
 S, T  
 :  
 S R  
**R4 D4**  
**X1 (VBS, VCS) 9V**

**2. Fault message : b-CT fault**

가 :  
 S CT  
 :  
 S CT  
 S CT 2

**3. Fault message : c-CT fault**

가 :  
 T CT  
 :  
 T CT  
 T CT 2

**4. Fault message : Tacho fault**

가 :  
 Tacho-Generator 가  
 :  
 Tacho-Generator

**5. Fault message : Fuse or LinePwr**

가 :  
 FDA unit Fuse 가  
 S, T  
 . (±20[%])  
 :  
 Fuse  
 S R  
 FDA unit

**6. Fault message : Over heat**

가 :  
 FDA unit 가 85  
 Fan ,  
 가 .  
 :  
 Fan .

**7. Fault message : Over current**

가 :  
 가 (Soft start time) OC Count  
 Set .  
 :  
 가 .  
 Soft start time, OC Count Set .  
 FDA unit 가 .

**8. Fault message : Over load**

가 :  
 :

**9. Fault message : Tacho line fault**

가 :  
 tacho generator feedback .  
 :  
 Tacho generator .

**10. Fault message : Over speed**

가 :  
 가 120% .

11. Fault message : **b Line fault**

가 : S V .  
: S V .

12. Fault message : **c Line fault**

가 : T W .  
: T W .